

Schraub-Printklemmen  
einteilig

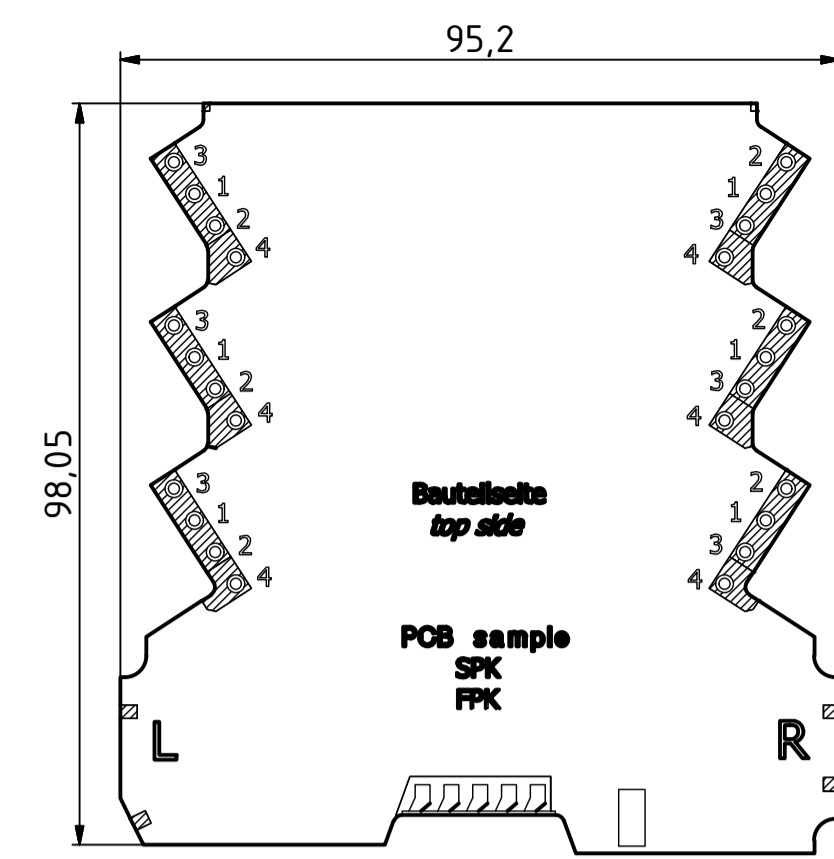

Federkraft-Printklemmen  
einteilig

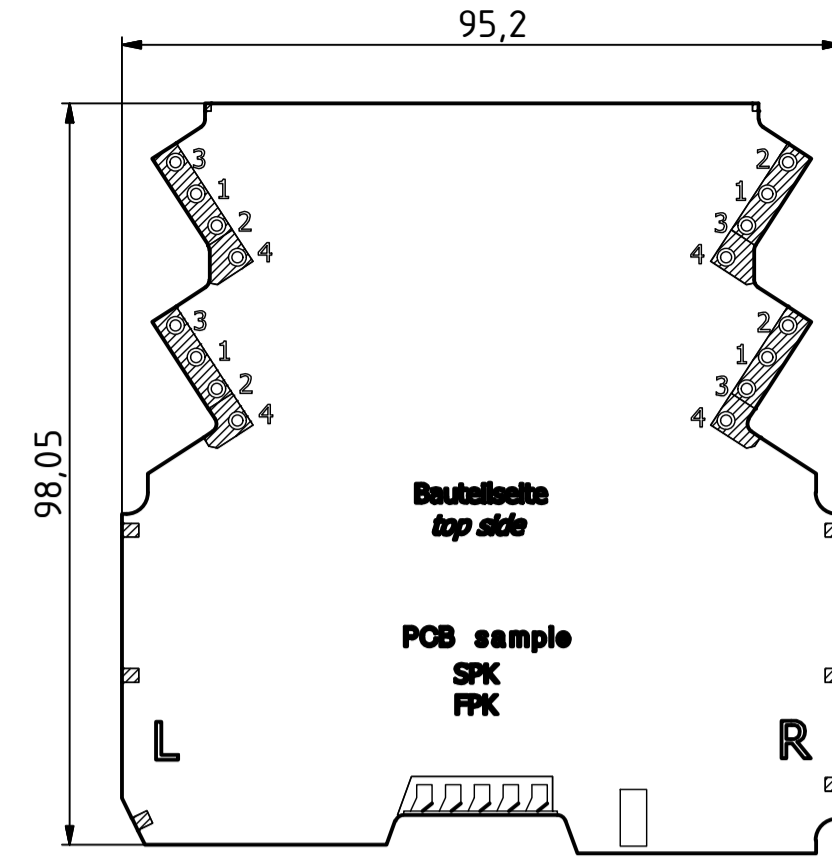
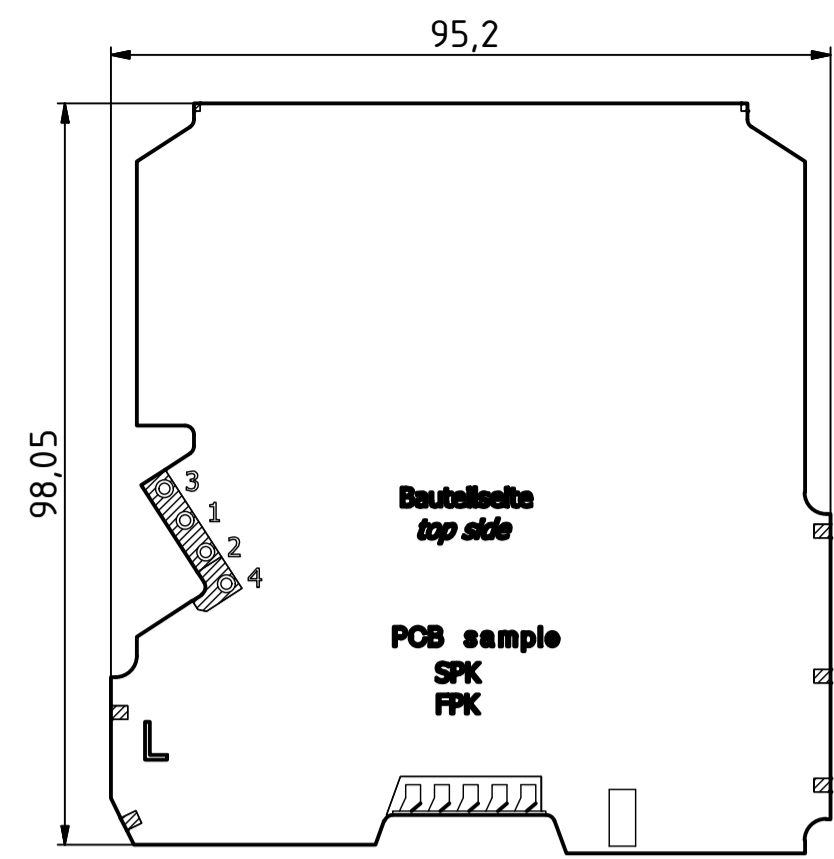
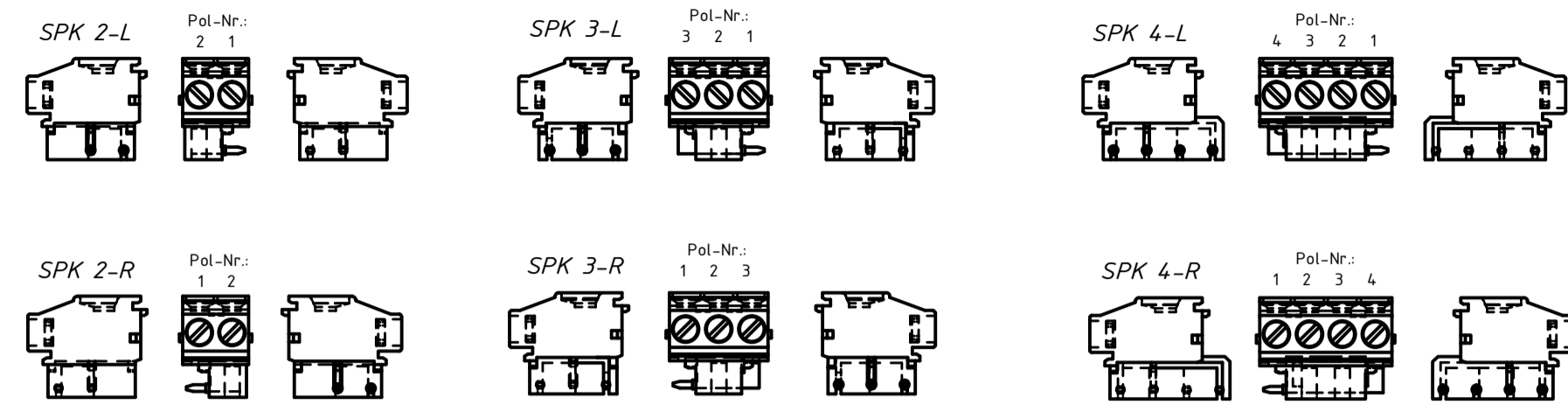
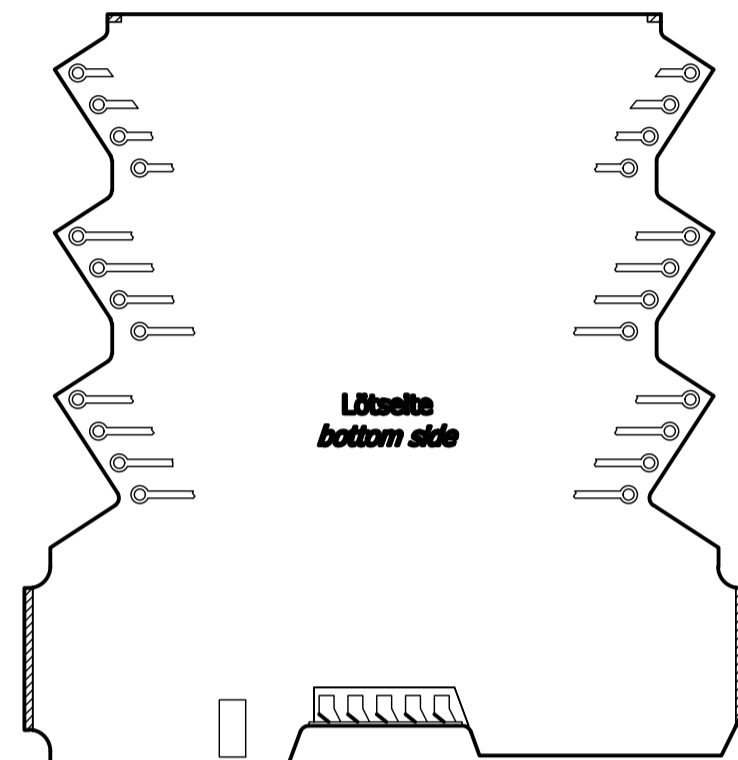
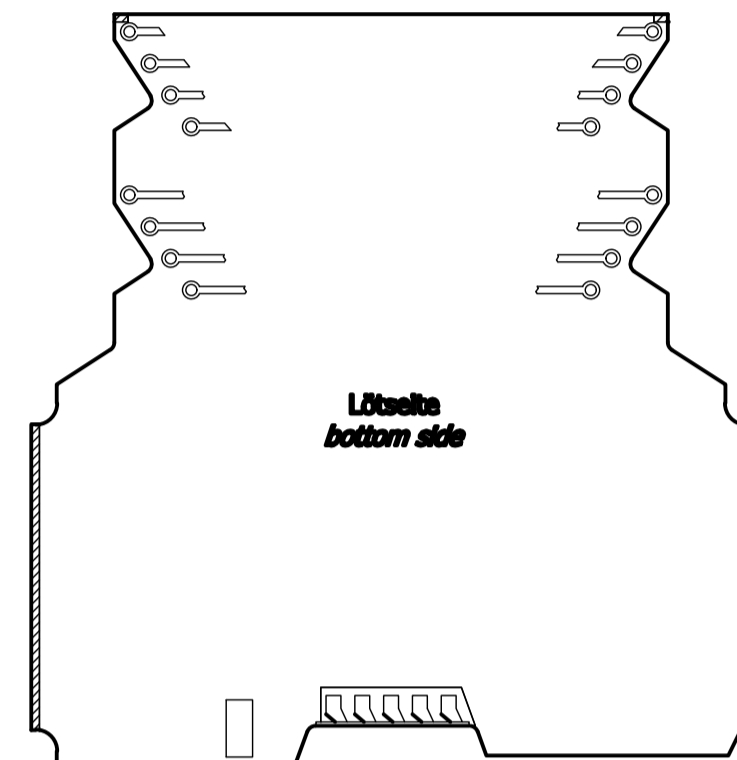
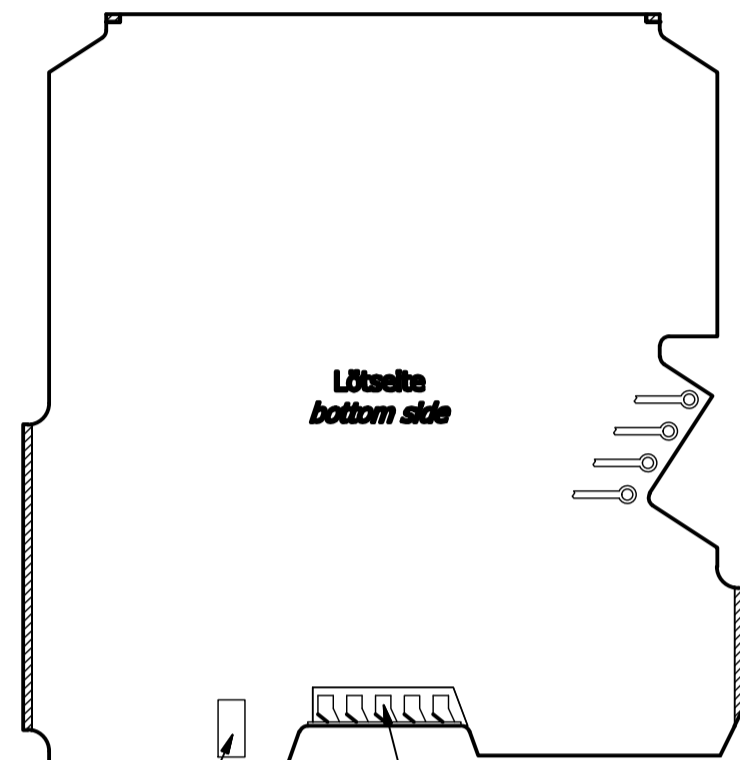
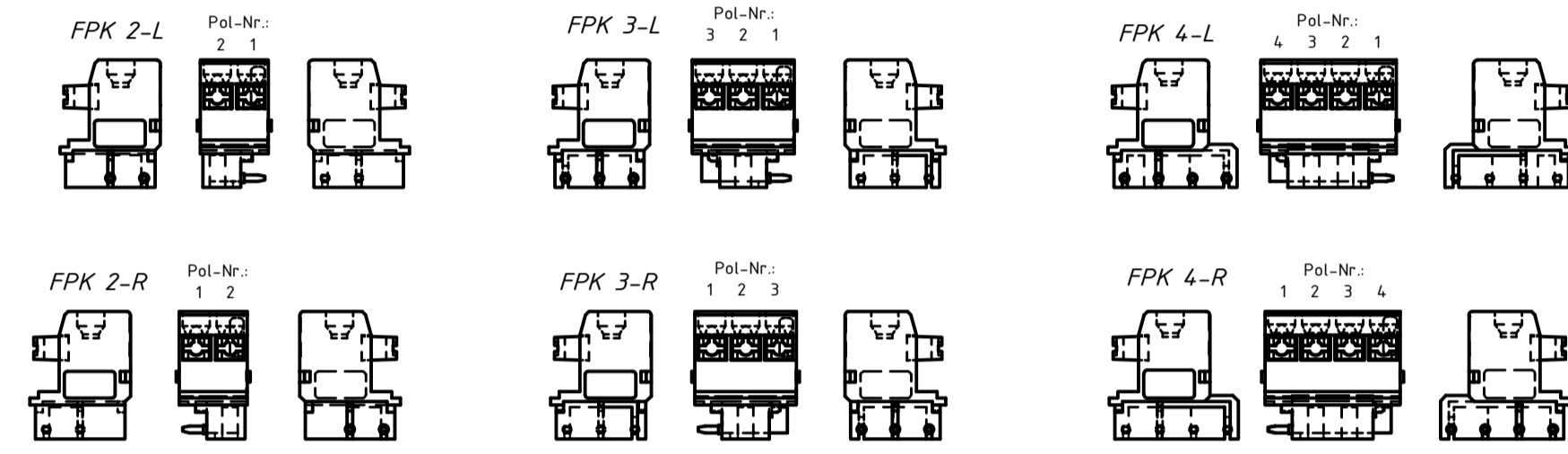

Kontaktfläche für PE-Kontakt  
verzinkt  
conductor area for PE-contact  
tin-plated

Kontaktflächen für Buskontakte  
vergoldet.  
Max. Strombelastung 30 Volt (120 Volt auf Anfrage)  
conductor area for buscontact  
gold plated  
max. current load 30 Volt (120 Volt on request)

Ausführung CNT-STL  
für CNT 12/6-\_\_ TB (-L)  
Execution CNT-STL  
for CNT 12/6-\_\_ TB (-L)

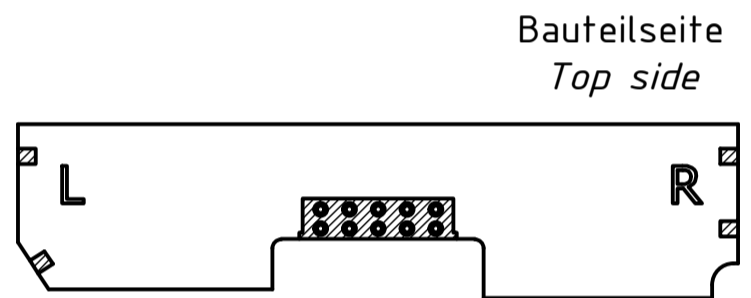

Schraub-Printklemmen  
zweiteilig

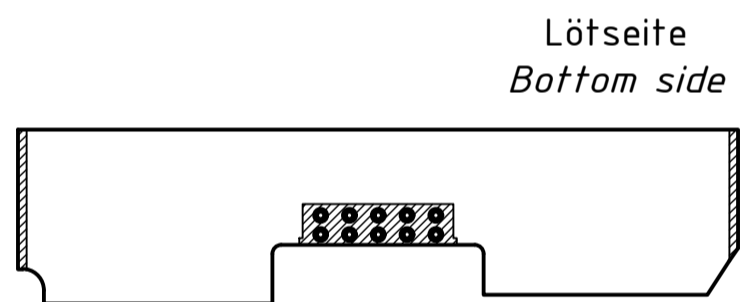
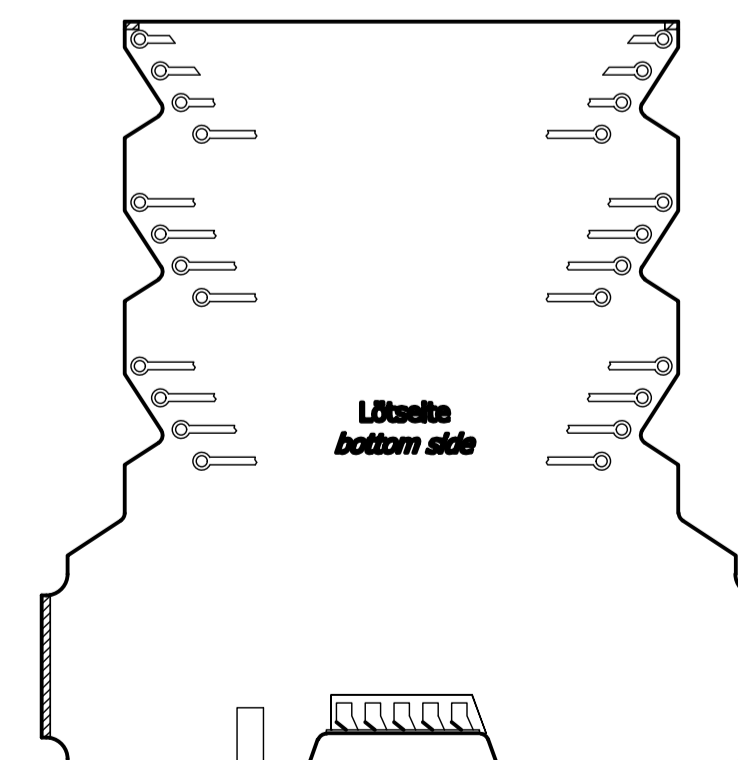
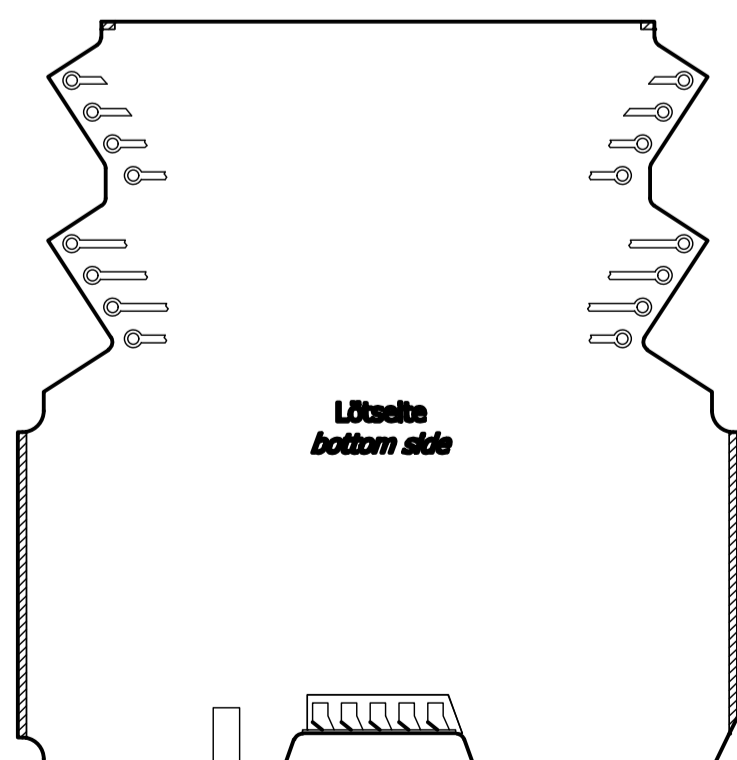
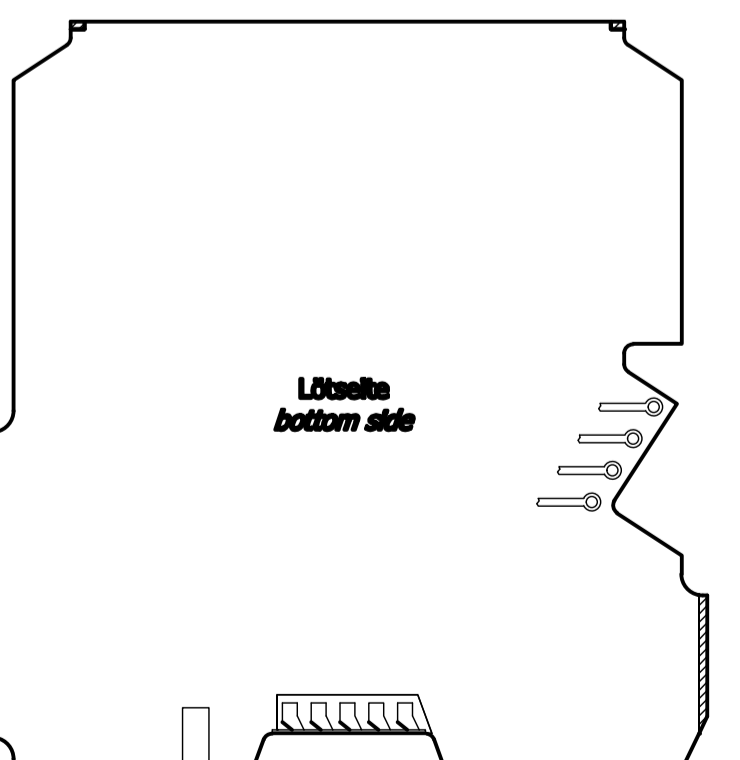
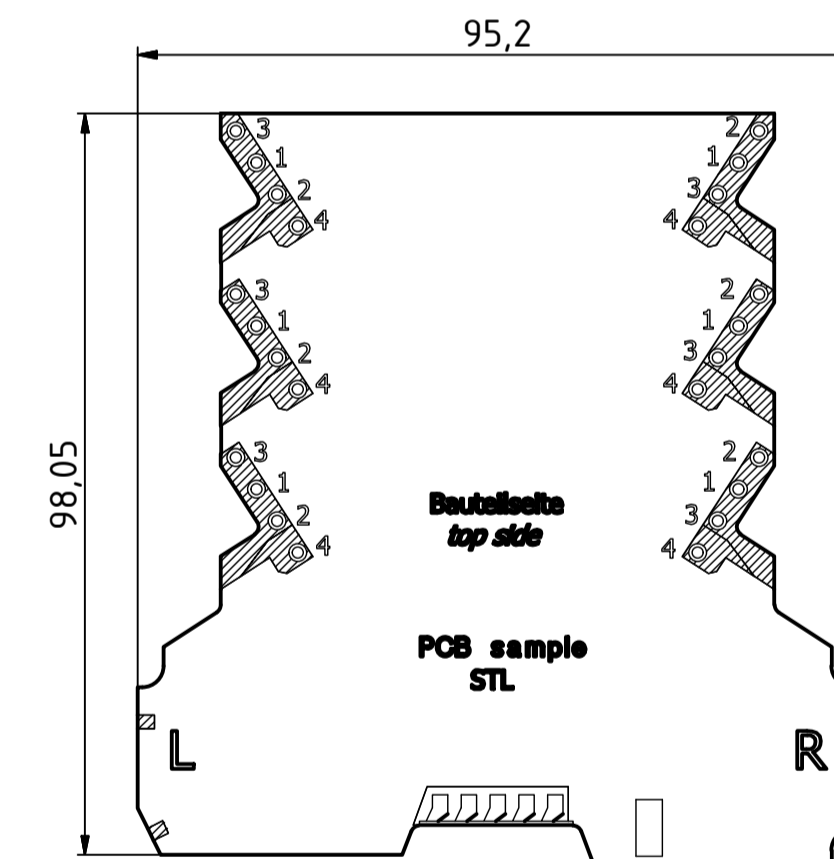
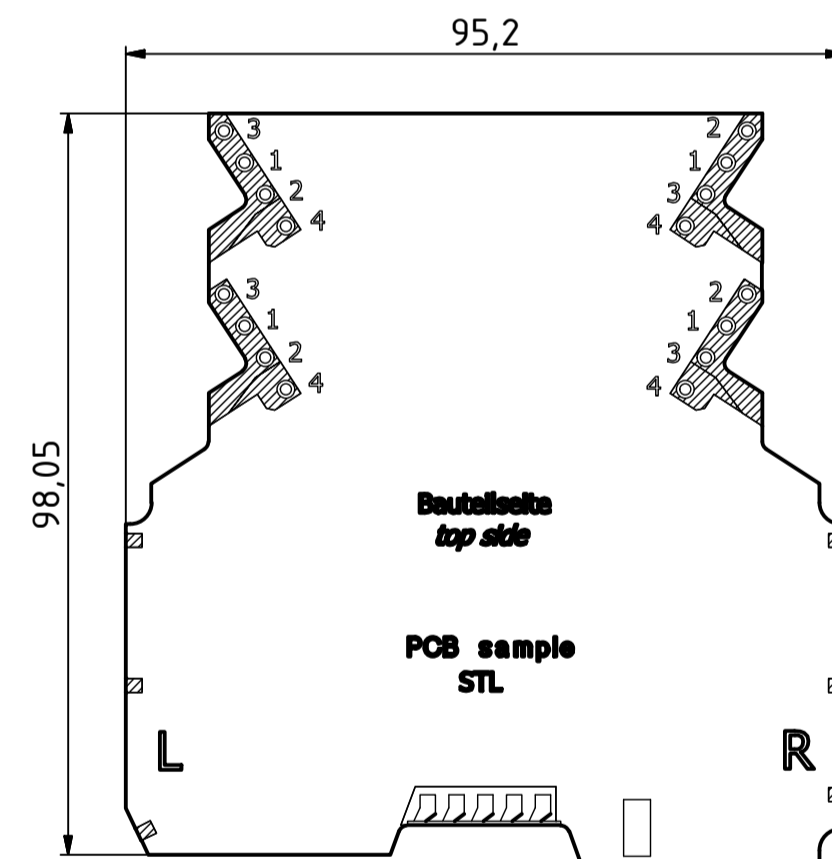
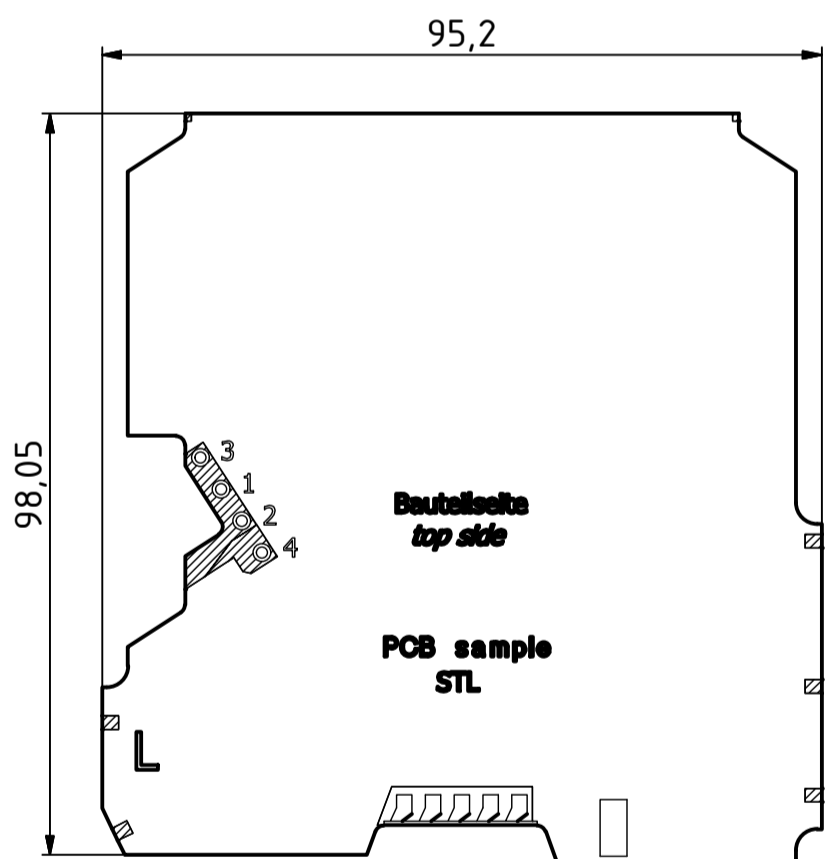
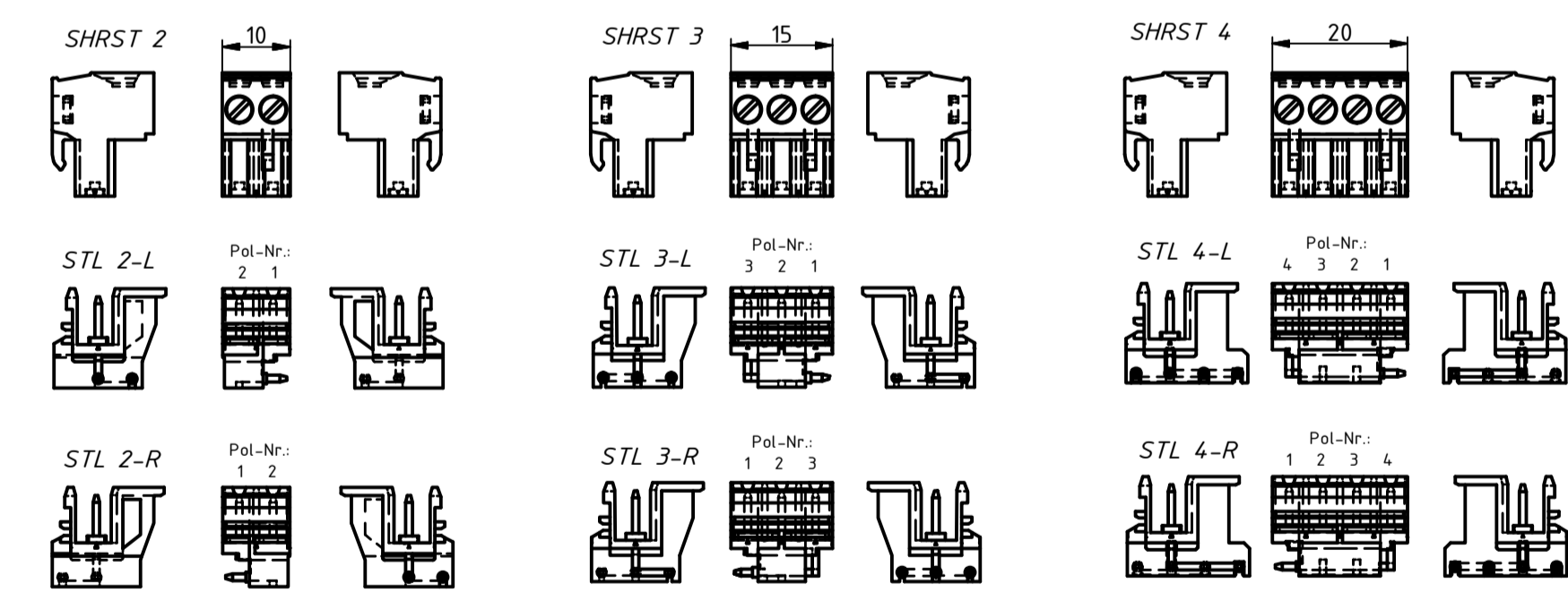

Nicht bestückbare Bereiche  
districted area

Maßstab/  
Scale: 1:1

Zeichnungs-Nr. / Drawing-No.:  
2K 5400.097.04

Artikel / Article:  
CombiNorm Connect  
Klemmen/Leiterkarten  
Katalogzeichnung

4227 17.08.2017  
4300 07.06.2016  
4030 07.01.2015  
A.Nr./  
Alt.No. Datum/  
Date:  
DISK: 2603329.idw  
Datum/Date: 31.01.2012 HR



A Phoenix Mecano Company