

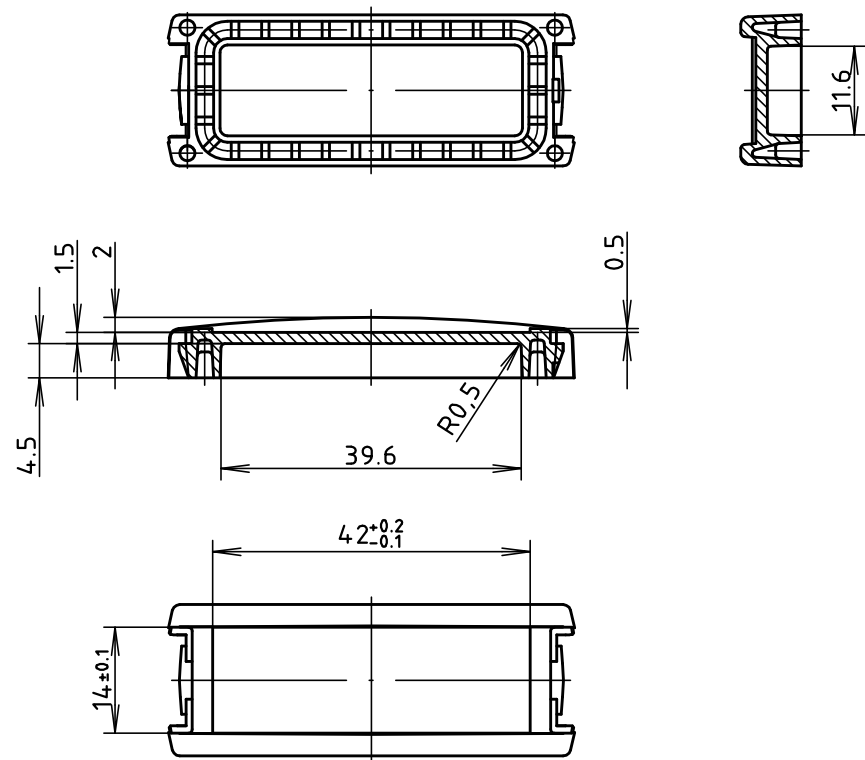

"Schutzvermerk nach DIN ISO 16016 beachten" "Please pay attention to copyright note DIN ISO 16016"

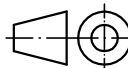

Maßstab/ Scale:	1:1	
Zeichnungs-Nr. / Drawing-No.: 3K 5300.280.01		
Artikel / Article: ART 225 KO Katalogzeichnung/Catalogue drawing -		
-	-	 BOPLA A Phoenix Mecano Company
-	-	
A.Nr/ Alt-No.:	Datum/ Date:	
DISK: 2 802 646		
Datum/Date: 30.11.05 KH		