

"Schutzvermerk nach DIN ISO 16016 beachten" "Please pay attention to copyright note DIN ISO 16016"

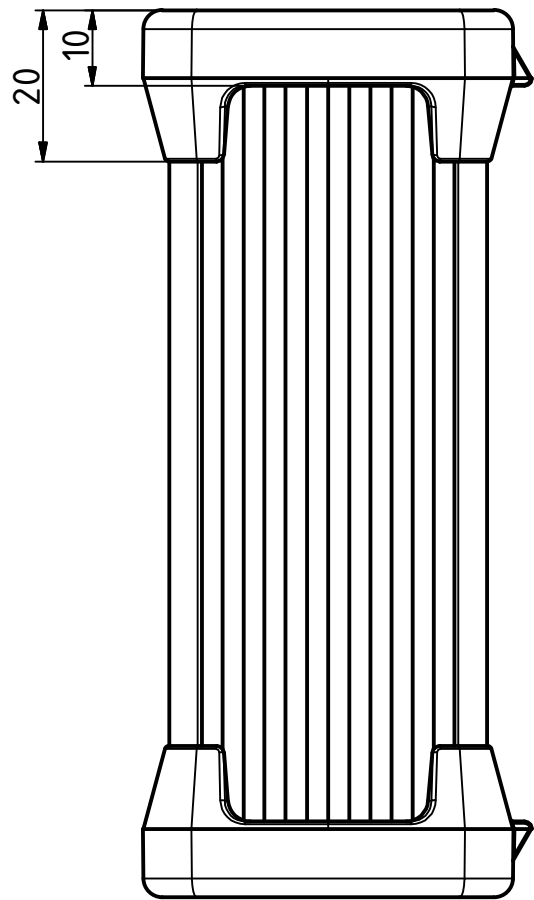

Gehäuseprofillänge L/
enclosure profile length L

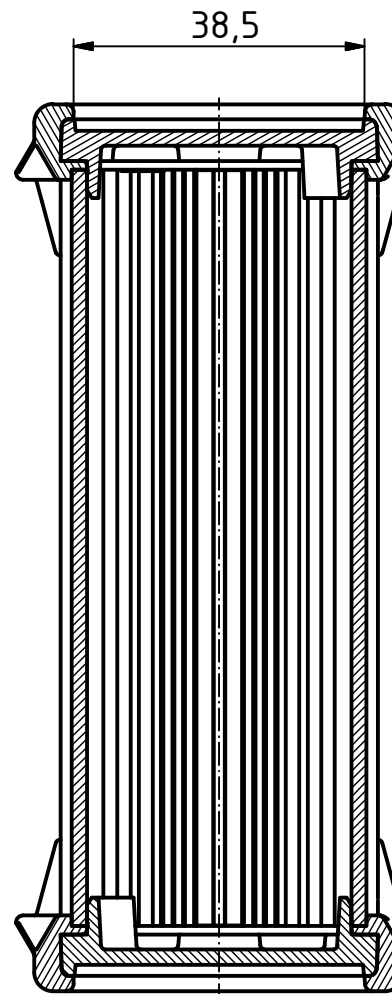
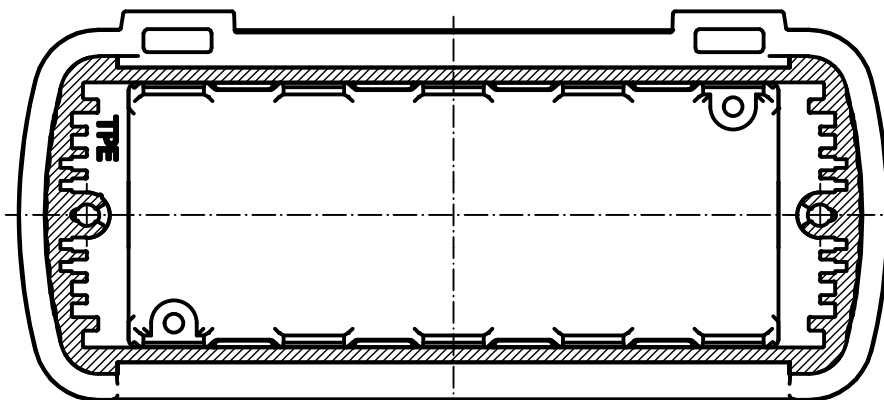
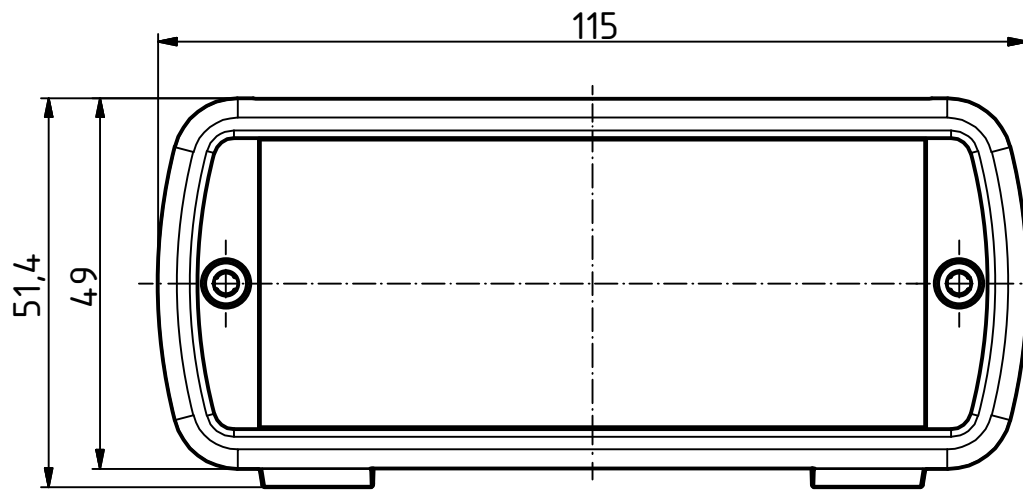
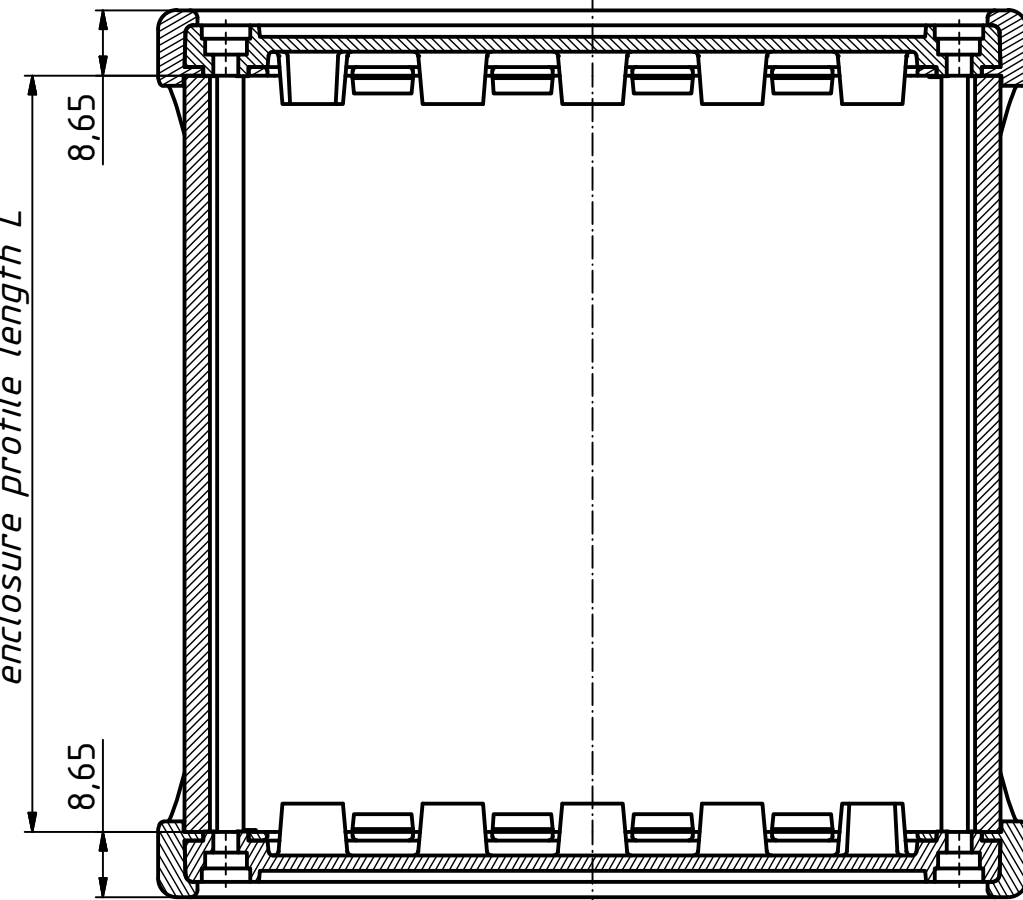

ISO (1 : 2)

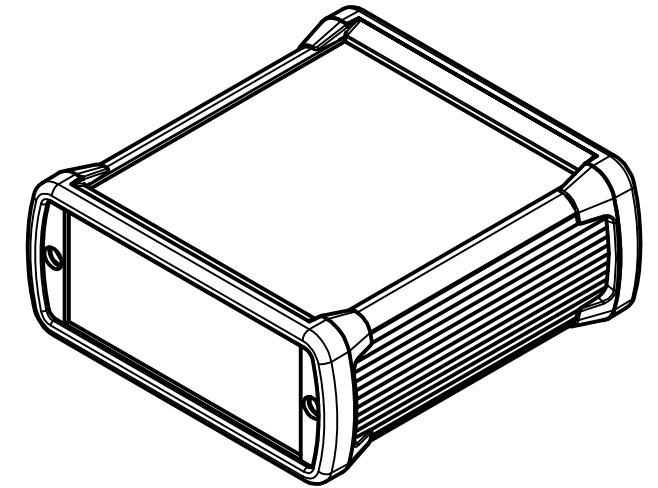

Maßstab/ Scale: 1:1 (1:2)

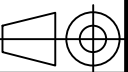

Zeichnungs-Nr. / Drawing-No.:
3K 5205.617.01

Artikel / Article:
ABD 1040 DI-S
Katalogzeichnung

Ä.Nr/
Alt.No:

Datum/
Date:



DISK: 2803803.idw
Datum/Date: 22.09.2015 KH